

# awave

*Owner's Manual*  
*Digital Signal Processor*



## **DSP 6-8**

**DIGITAL SIGNAL PROCESSOR**

**INDEX**

1. PRODUCT DESCRIPTION-PRECAUTIONARY NOTES.....02

2. PACKAGING CONTENTS.....02

3. DSP AND DRC INSTALLATION.....03

4. CONNECTION PANELS-DESCRIPTION.....04

    4.1 Input signals .....04

    4.2 Output signals .....05

    4.3 Input -remote control outputs and power supply.....05

5. CONNECTIONS.....06

    5.1 Power supply and remote turn on .....06

    5.2 Personal computer and Digital Remote Coontrol(DRC) .....07

    5.3 High-Level input signals .....07

    5.4 Low-Level input signals .....08

    5.5 Output signals .....08

6. SOFTWARE INSTALLATION.....09

    6.1 DSP GUI installation .....09-10

7. GUI OPERATION INSTRUCTION.....11

    7.1 Guide to GUI after installation .....11

    7.2 Interface introduction .....12-15

8. STAND INSTALLATION REFERENCE.....16

    8.1 5 channel stand alone treble mode .....16

    8.2 5 channel Passive X-Over treble mode.....16

    8.3 8 channel separate treble,middle mode .....17

9. REMOTE INTRODUCTION.....17

10. TECHNICAL FEATURES.....18

**1.PRODUCT DESCRIPTION-PRECAUTIONARY NOTES**

The DSP is a digital signal processor essential to maximize the acoustic performance of your car audio system. It consists of a 32-bit DSP processor and 24-bit AD and DA converters. It can connect to any factory system,even in vehicles featuring an intergrated audio processor,since,thanks to the De-equalization function,the DSP will send back a linear signal. It features selectable High and low level inputs as well as 3.5MM Aux and digital inputs that feed 8 completely variable output channels. Each output channel has a 31-band equalizer available.it also features a 66-freqency electronic crossover as well as . BUTTERWORTH or LINKWITZ filters with 6-24dB slopes and a digital time delay line.the user canselect adjustments. That allow him or her to interact with the DSP through a remote control device called DRC.

**WARNING:** 1-a PC provided with Windows XP,Windows Vista or Windows 7 operating system, 1.5GHz minimum. Processor speed , 1 GB RAM minimum memory and a graphics card with a minimum resolution. Of 1024x600 pixels are required to install the software and setup the DSP. 2-Before connecting you DSP, carefully read this manua .Improper connections may cause damage to The DSP or to the speakers in the car audio system.

**2.PACKAGING CONTENTS**

- DSP- Signal Interface Processor



- Power supply cable/Remote/wifi/Inputs



- 5.0m USB cable

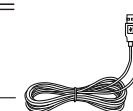

- Control High Level Input



- 4 of 4.0\*15 mm self-tapping, Cross-head fixing screws,



- CD ROM with:  
    DSP 1.0 software  
    This advanced manual(.pdf format)  
    Test tracks



**OPTIONAL:**

- DRC(Digital Remote Control)control panel:



- 5.0 m DRC-AC Link cable

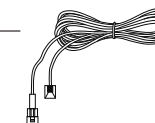

### 3.DSP AND DRC INSTALLATION

#### External dimensions

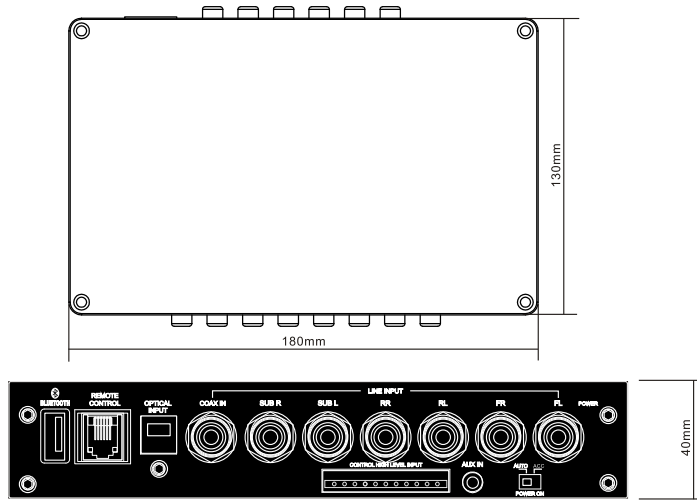

#### How to install



**WARNING:** do not use aggressive cleaning agents or abrasive cloth to clean the display. Simply use a soft cotton cloth lightly damped with water.

### 4.CONNECTION PANELS-DESCRIPTION

#### 4.1 Input signals

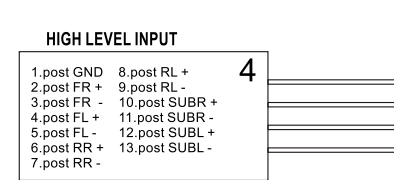
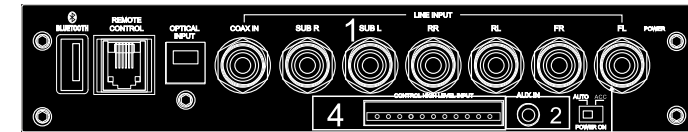
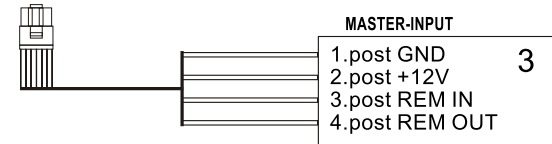
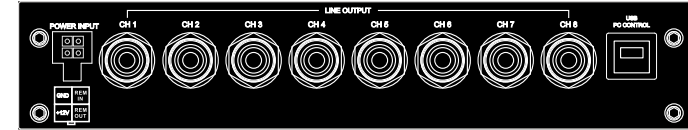

#### 1. INPUTS;FR-FL-RR-RL,SUB R-SUB L inputs(SPEAKERS)

The DSP comes with 6 HI-LEVEL signal inputs to connect amplified signal cables coming from the main Analog source.input sensitivity is adjustable from 2 to 15V RMS.

#### 2. AUX IN L-R; auxiliary low-level stereo input.

The DSP comes with an auxiliary stereo signal input to connect an external source, mp3 Player,audio. Sources.Input sensitivity is adjustable from 0.3 to 5 V RMS.

**Remark:** if a low-level output source (PRE OUT)with output signal equal or greater than 2 V RMS is available, you can Connect it to the high-level MASTER input(SPEAKERS). Sensitivity is increased by adjusting the IN LEVEL controls.

### 4.2 Output signals

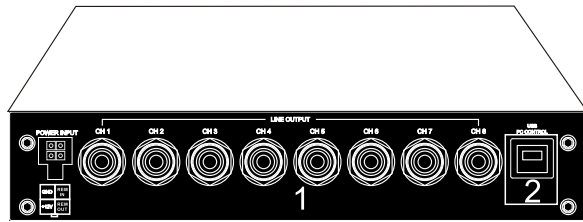

- 1.FRONT1/A+B To Midrange  
FRONT2/C+D To Tweeter  
Rear/E+F To Midbass  
Subwoofer /G+H To Subwoofer

- 2.USB  
USB(type B)connection plug, to connect the processor to a PC and manage its functions through the DSP 3 Software. The connection standard is USB 1.1/2.0 compatible.

### 4.3 Input - remote control outputs and power supply

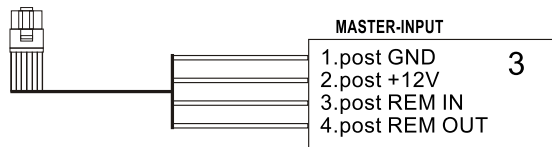
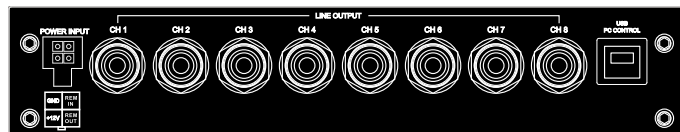

- 1. POWER SUPPLY.**  
+12V:Positive connection terminal for car 12V power supply.  
GND:Power supply negative connection terminal(GND).  
**WARNING:**make sure the connection polarity is as indicated on the terminals.A misconnection. May result in damage to the DSP. After applying power,wait at least 10 seconds Before turning the DSP on.
- 2. REMOTE IN-OUT.**  
REM IN:input to turn on the processor remotely along with the audio signal remote Out.  
REM OUT:output to turn on other devices/amplifiers connected after the processor.  
From the REMOTE-IN signal, the processor only takes 1second to supply the signal to the REM OUT output. The 130-mA output current capability can also drive an automotive relay (Making sure it does not exceed 130 mA).
- 3. OPTICAL INPUT**  
**WARNING:**the DSP must be switched on before any amplifiers are turned on.  
The system sources Remote Out must be connected to the product REM IN,and the product REM OUT. is then to be connected to the Remote In of other devices/amplifiers.

## 5.CONNECTIONS

### 5.1 Power supply and remote turn on

**WARNING:** to power the device,use 1 mm<sup>2</sup>(16 AWG) cables.

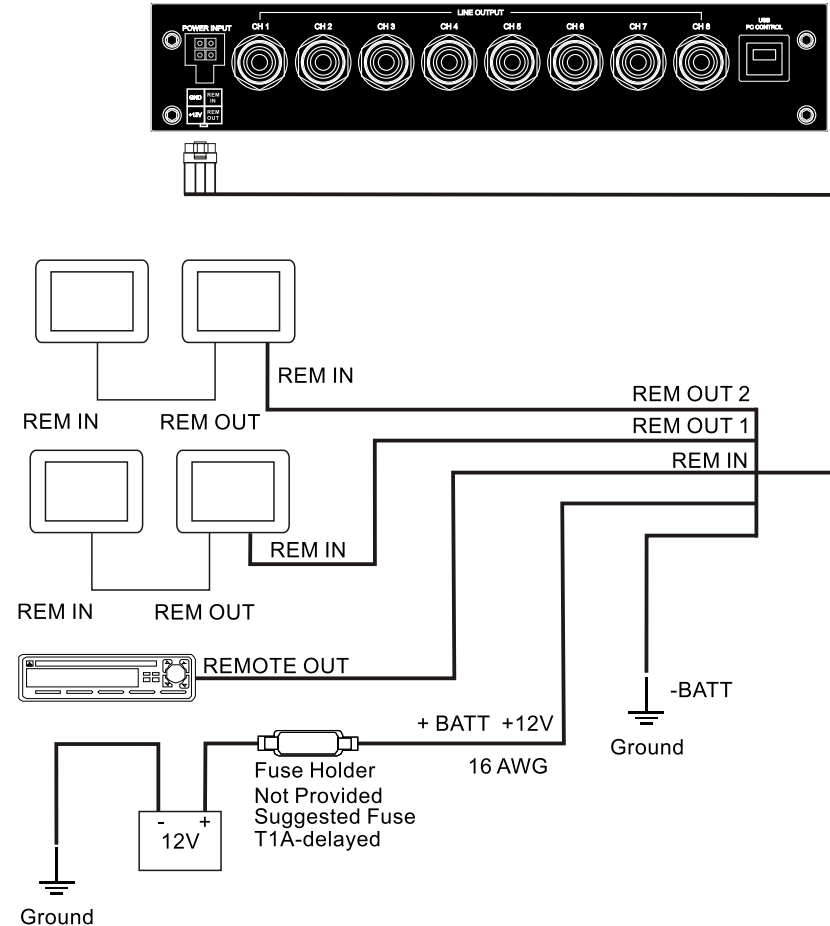

**Remark:** the DSP is internally protected by a Fuse-resistor soldered on its printed circuit board To replace it contact a service center. Using an External fuse is recommended, though it is not required.



### 5.2 Personal computer and Digital Remote Control(DRC)

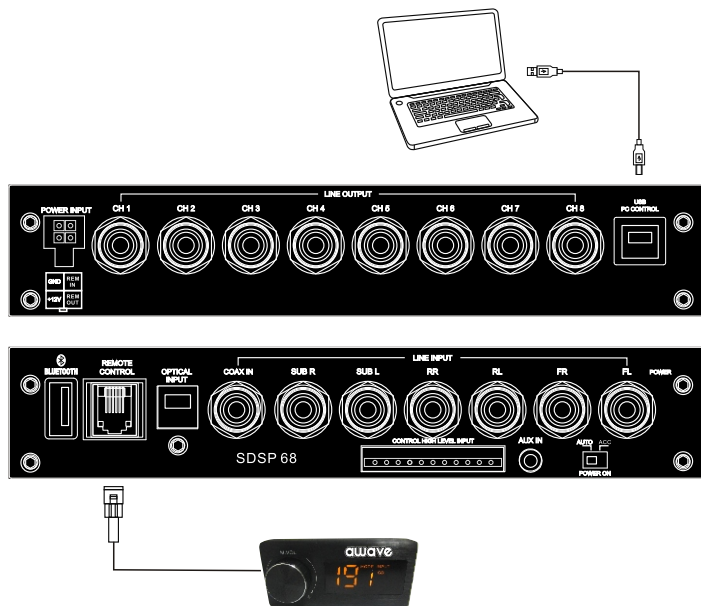

### 5.3 High-Level input signals

1.SPEAKERS IN HI-LEVEL STEREO FRONT+REAR .

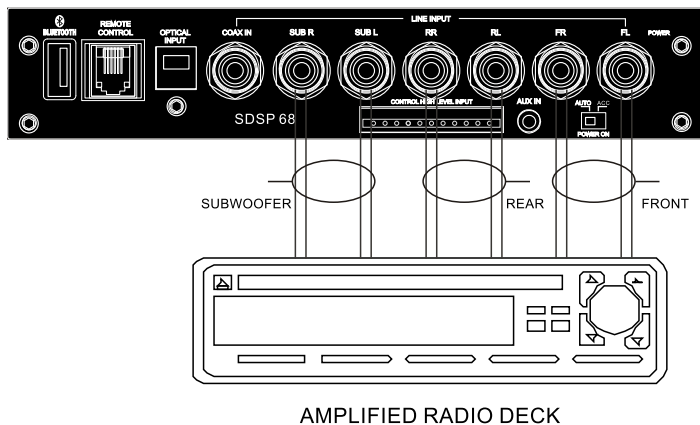

### 5.4 Low-Level input signals

AUX IN L/R: Auxiliary analog stereo signal .  
Sensitivity is adjustable from 0.6 to 5V RMS .  
BlueTooch IN : Auxiliary analog stereo signal .

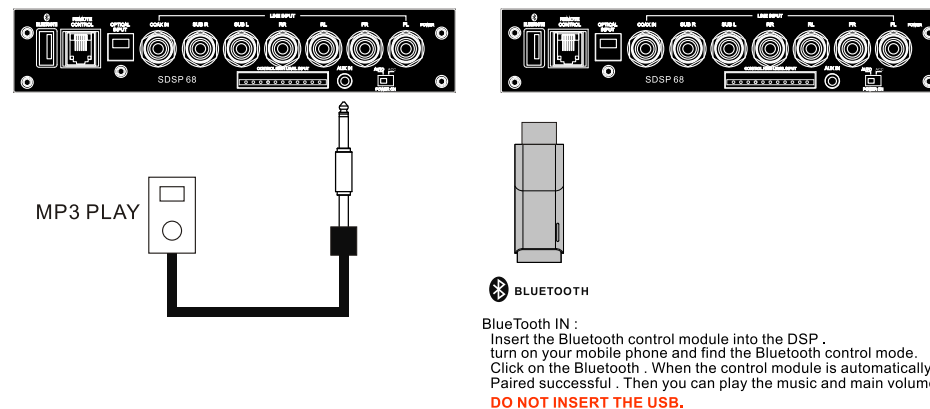

BlueTooch IN :  
Insert the Bluetooth control module into the DSP .  
turn on your mobile phone and find the Bluetooth control mode .  
Click on the Bluetooth . When the control module is automatically  
Paired successful . Then you can play the music and main volume control .  
**DO NOT INSERT THE USB.**

### 5.5 Output signals

Output to an amplifier is system .

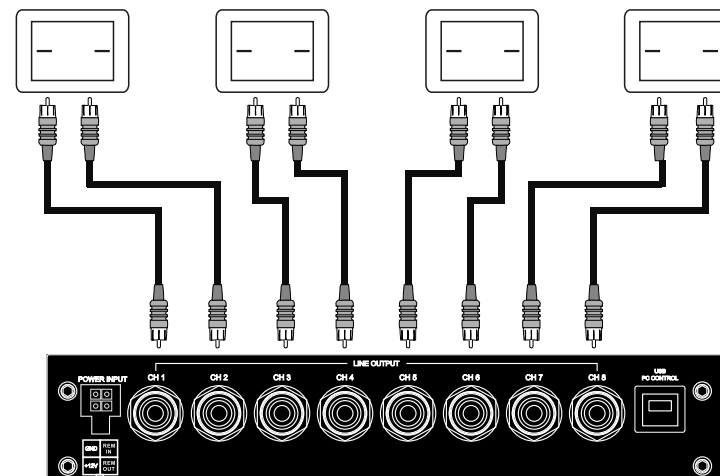

6. SOFTWARE INSTALLATION

6.1 DSP GUI installation

1. Insert CD, Double-Click DSP

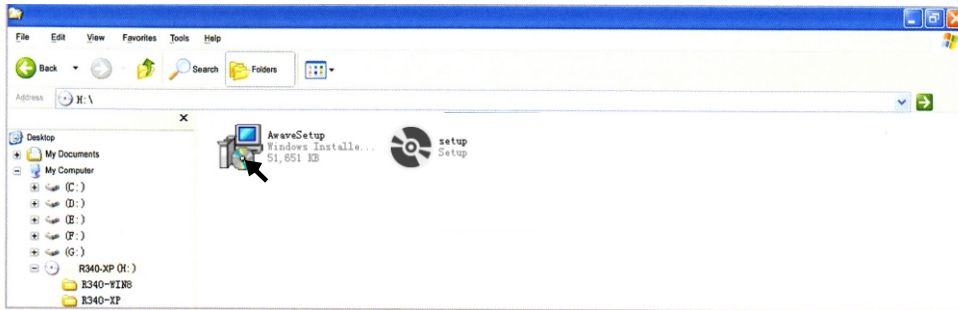

2. Click NEXT

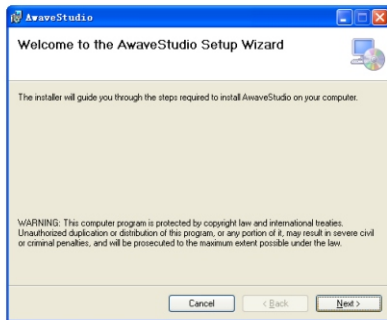

3. Click NEXT

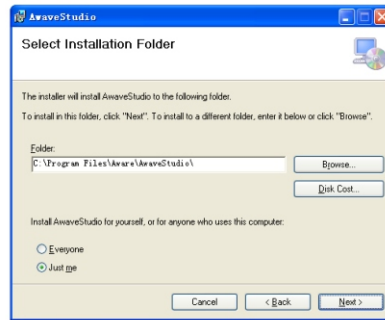

4. Click NEXT

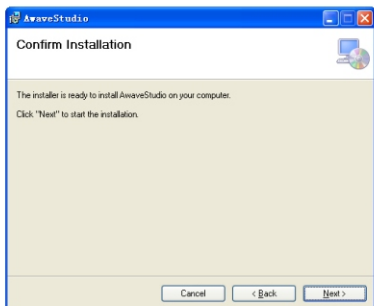

5. Click NEXT

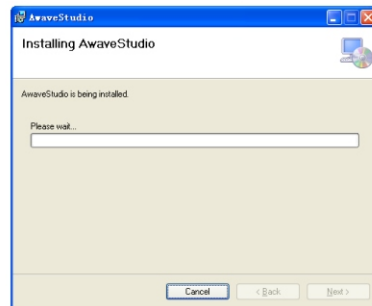

6. Installation completed, Close

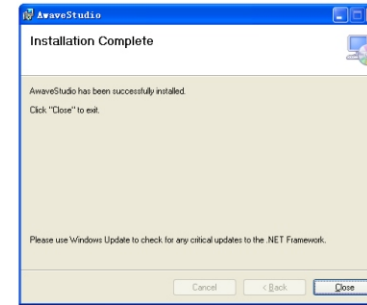

7. GUI OPERATION INSTRUCTION

7.1 Guide to GUI after installation

1. Double-click icon of DSP-CONTROL



2. DSP connection



3. Enter the GUI you long for! Now you could tone every signal details as experts do To bring sound effect on your beloved car to a higher level. If the password has been set, You need to enter the password.

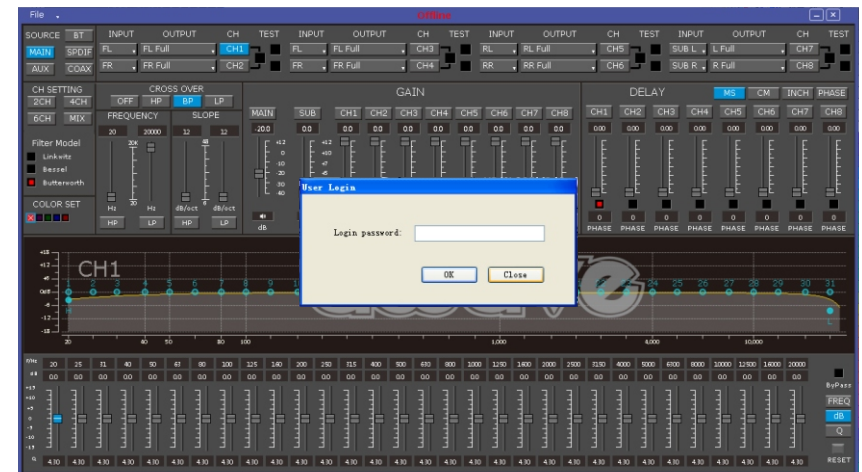

7.2 Interface introduction  
1.DSP interface guidance



2. "FILE" MAIN MENU 1

1. Connect(connect to the DSP)



2. Language(choose you need language)



3. Open(Toload preset file in PCfolder)
4. Save(To save setting to PC)
5. Save as(To save another file setting to PC)
6. Restore Factory(To save preset file in DSP)
- 7.Modify Password

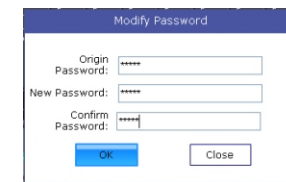
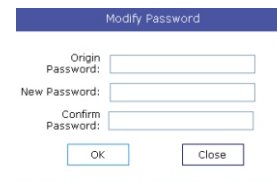

8. Write To Device
  9. Read From Device
  10. About
  11. Exit
3. INPUT MODE.  
To select different input devices.

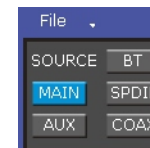

4. CHANNAL SETTING.  
① CH mode(2CH 4CH 6CH MIX).

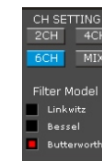

- ② Input channel:FL. FR. FL. FR. RL.RR. SUB L. SUB R.  
When you click the drop-downbutton, you can choose thestate of the channelinput.  
There is : FR. FL.RR. RL. SUB R. SUBL.M1=FL+FR.M2=FL+RL.M3=FR+RR.  
M4=FL+RL+SUBL.M5=FR+RR+FUBR.

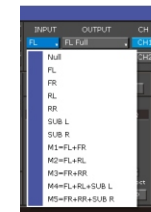

③ Output channel:FL FullRange.FR FullRange.

When you click the drop-down button, you can choose the state of the channel input. There is : Null.Front.Rear.Center.Subwoofer and Full.Tweeter.Mid-T.Midrange.M-WF. Woofers.

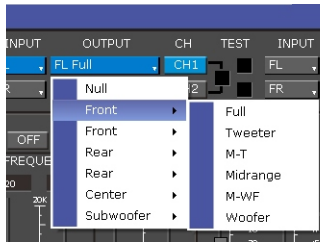

Options on the "Link" are for combine setting for Left CH and Right CH. Options on the Left CH/right CH allow you to tone each selected channel respectively.

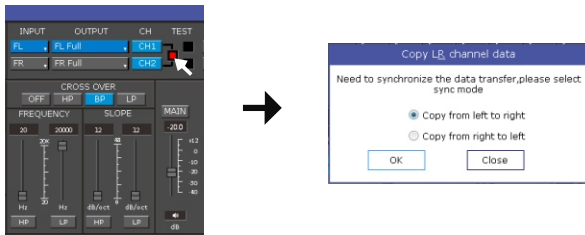

5. CROSSOVER X-TPE.

To choose different crossover type, for example select CH selection on 3RD spot .that would locate CH you want to choose for crossover configuration .

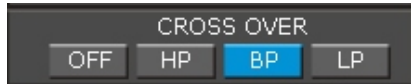

6. CROSSOVER FREQUENCY.

Set frequency of LP/HP individually .

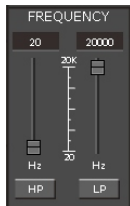

7. GAIN.

0--40dB is optional range for gain control kfevery CH.



8. DELAY.

- 1.Auto configuration(base on 1.5 setting).
- 2.Manual configuration, change specifications in selected CH manually.

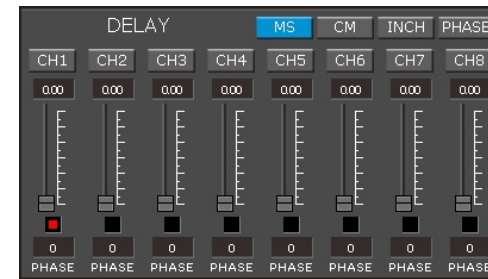

9. LP/SLOPE.

1.6dB/oct 12dB/oct 18dB/oct 24dB/oct 30dB/oct 36dB/oct. 42dB/oct 48dB/oct are available.

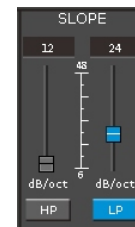

10. HP/SLOPE.

1.6dB/oct 12dB/oct 18dB/oct 24dB/oct 30dB/oct 36dB/oct.42dB/oct 48dB/oct are available.

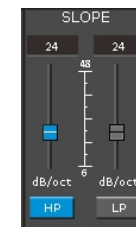

11. Filter Model.

To choose different Filter type Linkwitz Bessel Butterworth.

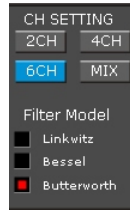

12. WRITE.

To Write To Device (POS1-POS8).

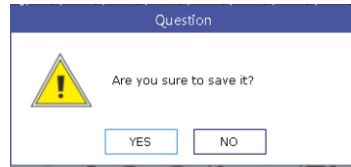
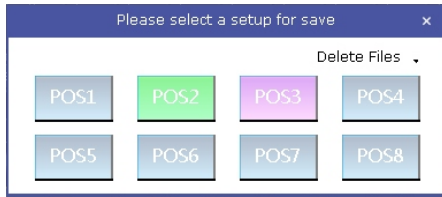

13. READ.

To Read From Device (POS1-POS8).

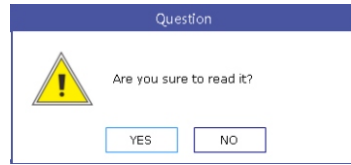
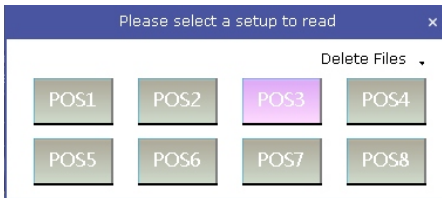

14. X-OVER AND EQ CHARTS.

1. Red lines and slopes will change accordingly when HP/LP of crossover and EQ are modified.
2. EQ all frequency points can be move left or right. For 20Hz-20kHz can be any Regulation.

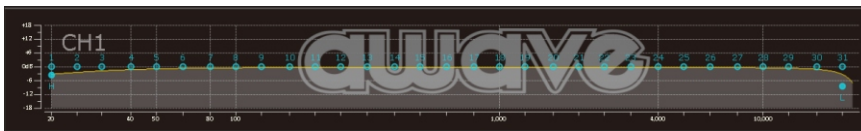

15. EQ SETTING.

Q value=1-12.

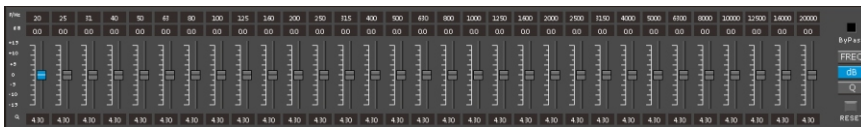

8. STAND INSTALLATION REFERENCE

8.1 5 CHANNEL STAND ALONE TREBLE MODE

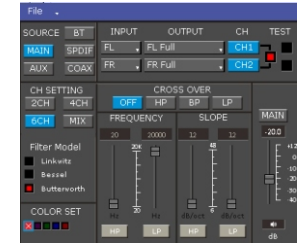
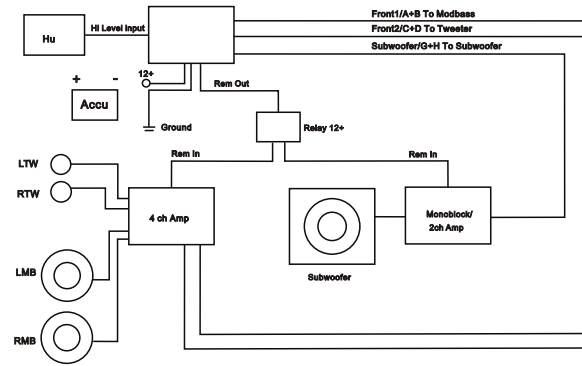

8.2 5 CHANNEL PASSIVE X-OVER TREBLE MODE

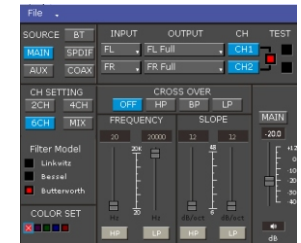
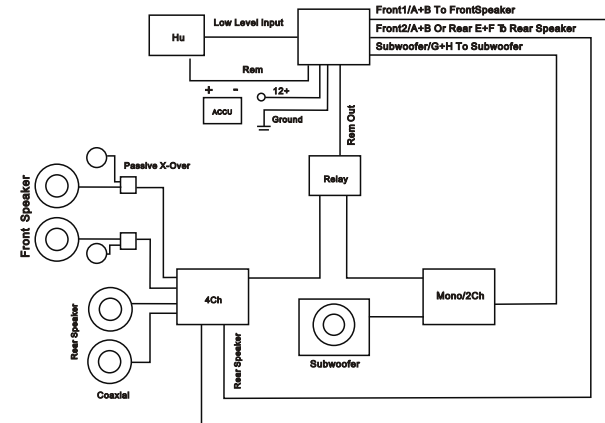

8.3 8 CHANNEL SEPARATE TREBLE,MIDDLE MODE

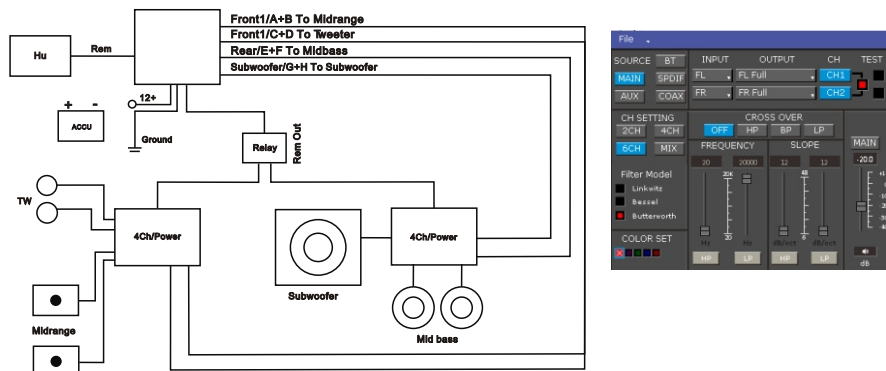

9.REMOTE INTRODUCTION



1. A.Main volume.
- B.When you press this button for a short time,It is in the "MUTE" state. And theclose "MUTE".
- C.When you press this button for a longer time(for a second) ,It will enter the menu mode .  
In the "MODE" or "INPUT" flashing. You can adjust the mode which you want.
- 2.Main volume display window.
- 3.DSP mode display window(1-8).
- 4.Input display status.(CD.AUX.SPDIF.WIFI).

10.TECHNICAL FEATURES

POWER SUPPLY	
Voltange	9.0-15VDC
Idling current	0,5A
Switched off without DRC	5mm
Switched off with DRC	4mA
Remote IN voltage	6-15 VDC
Remote OUT voltage	12 VDC(130mA)

SIGNAL STAGE	
Distortion - THD @ 1kHz, 1V RMS Output	0,0004%
Bandwith @-3 dB	20-22kHz
S/N ratio @ A weighted	
Master Input	98 dBA
Auxinput	96dBA
Channel Separation @ 1 kHz	90 dB
Input Sensitivity(Speaker In)	2-15 V RMS
Input Sensitivity(Aux In)	0,2-5 V RMS
Input Sensitivity(Phone)	
Input Sensitivity(Speaker In)	10kΩ
Input Sensitivity(Aux)	22kΩ
Input Sensitivity(Phone)	
Max OUTPUT Level(RMS) @ 0.1% THD	4 V RMS

INPUT STAGE	
High Level(Speaker)	FL-FR-RL-RR-SUBL-SUBR,Phone IN
Low level(Pre)	FL-FR-RL-RR-SUBL-SUBR, AUX IN

OUTPUT STAGE	
Low level Pre(default)	Midrange(A+B)/Midbass(E+F)/Subwoofer(G+H)

CONNECTION	
From/To Personal Computer	1 x USB/B(1.1/2.0) 5M

CROSSOVER N.5(one each output channel)	
Filter Type	Full/High/Low Pass /Band Pass
Slope Setting	6/12/18/24/30/42/48 dB
Crossover frequency	68 steps @ 20- 20kHz
Phase control indepent setting for each channel	0 - 180°